

Venting Guidelines

Some Popular Venting Strategies**

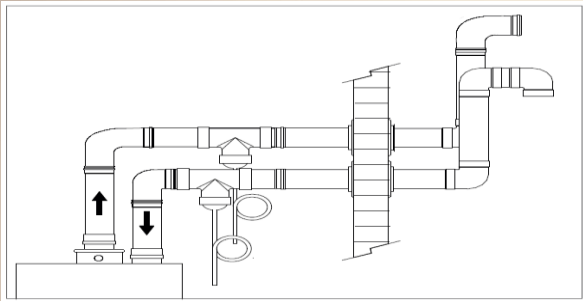

Co-Linear Venting (S636 PVC)

2"	65' (65' Intake max. & 65' Exhaust max.)
3"	150' (150' Intake max. & 150' Exhaust max.)

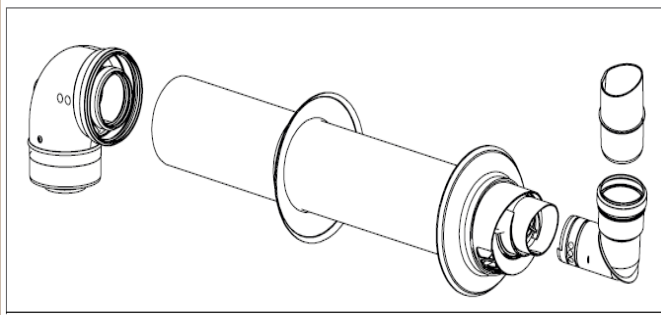

Co-Axial Venting (Polypropylene)

	Min	Max
100mm/ 60mm	1' + elb.	19' + elb.

Note: Elbow allowance - 45° = 2.5'

90° (long radius) = 5'

90° (short radius) = 7.5'

* Always check local code requirements

** Other approved venting options are available, please refer to the Radiant Installation & Operation Manual for full details